













Hardware List					
a, bolts 5/16"x1-1/2"		4pcs	g, hole cover		1pc
b, bolts 5/16"x1-1/4"		4pcs	h, hole cover		1pc
c, flat washers		8pcs	i, shelf pin		2pcs
d, lock washers		8pcs	j, keys		2pcs
e, wrench		1pc	k, the power outlet		1pc
f, screws		12pcs			

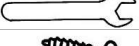

Step 1: Connect Back Panel(B), Side Panel(C) and Right Base(D) by using Bolts(a & b), flat washers(c) and lock washers(d) with wrench(e). But do not tighten them firmly at this moment.

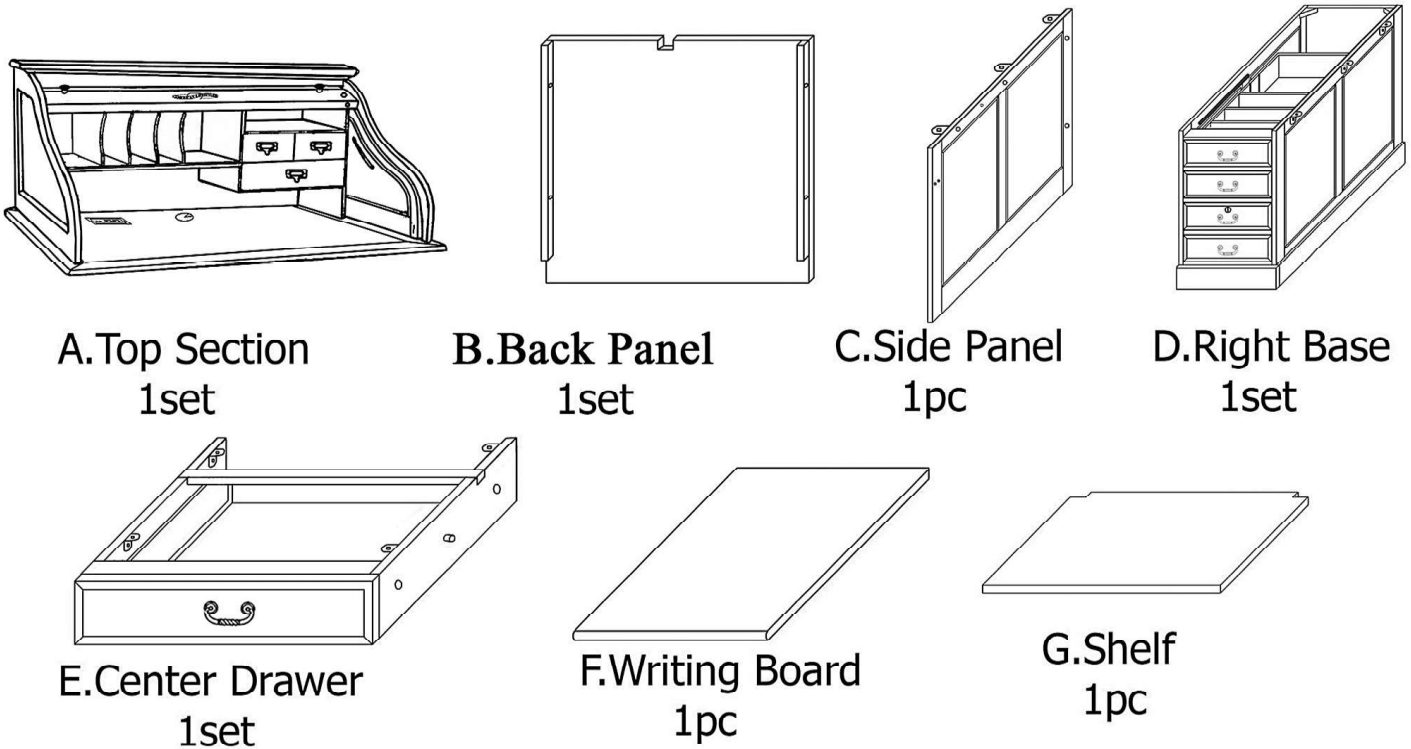
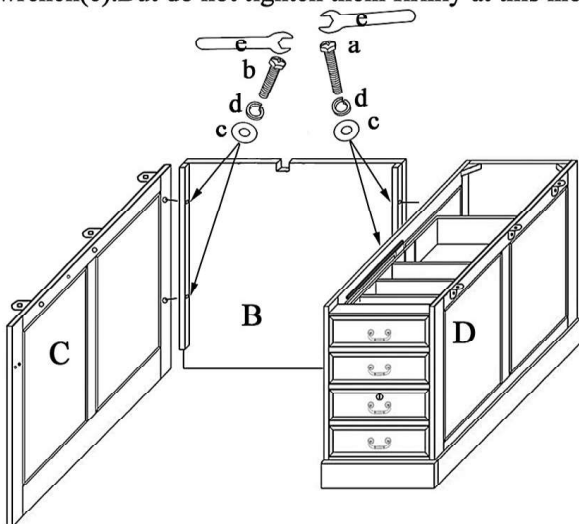

Step 2: Put Center Drawer(E) in the place between Side Panel(C) and Right Base(D), then connect them by using bolts(a & b), flat washers(c) and lock washers(d) with wrench(e). Tighten them firmly.

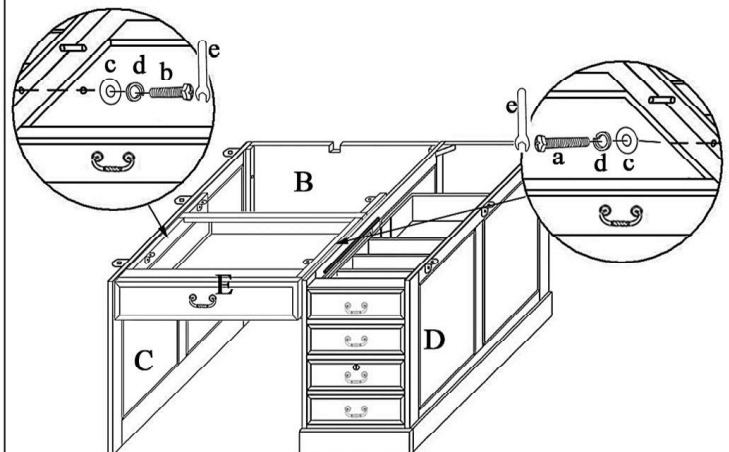

Step 3: Put the Writing Board(F) on the top of Right Base(D).

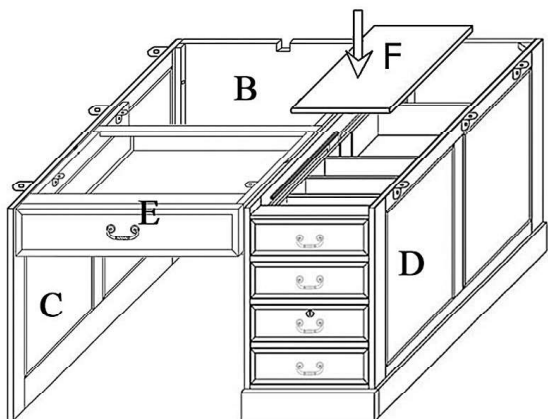

Step 4: Place the Top Section (A) to the Base, then using Screws(f) connect them together.

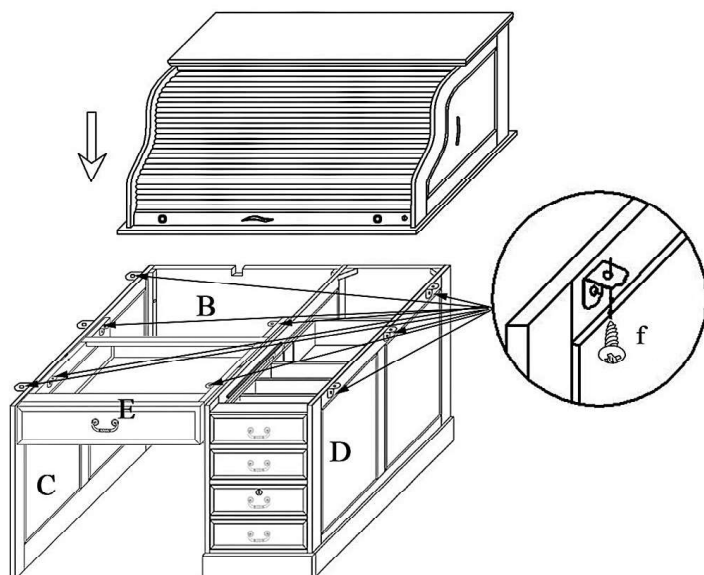

Step 5: Put the Shelf Pin(i) into hole of the Base and then put the Shelf(G) on them.

Step 6: Insert the Hole cover(h) into the hole on the Desk Top.

Step 7: Use screw to attach the power outlet on the Desk Top.

