

CADB962

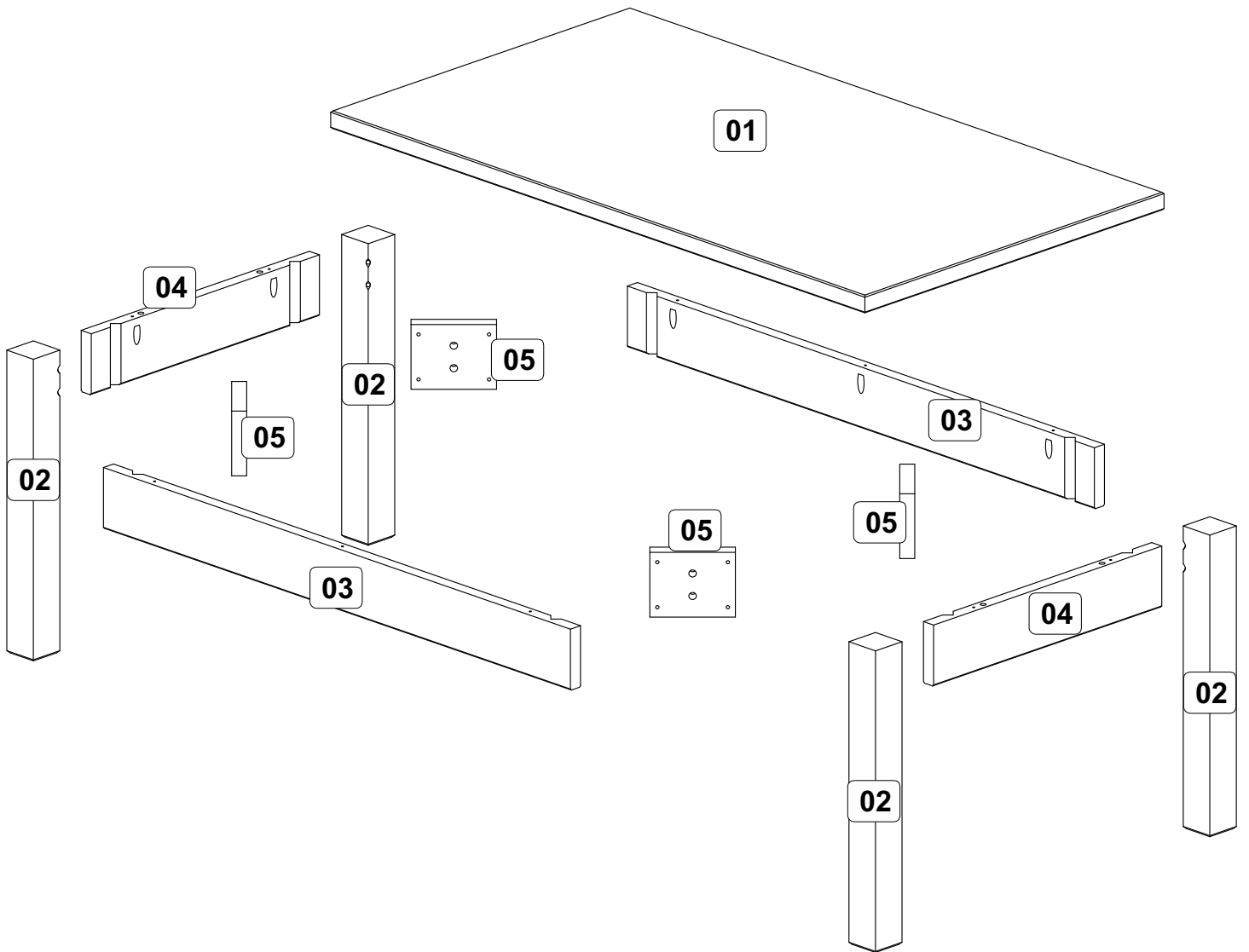

CADB962

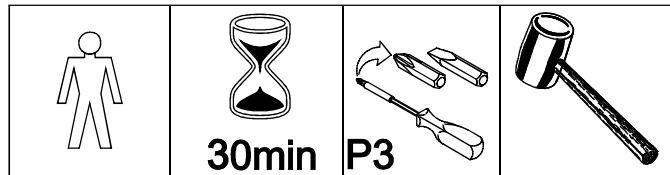

Thank you for choosing this furniture.

BEFORE YOU START ASSEMBLY please store the carton at room temperature for 48 hours or more so the contents can acclimatise.

PLEASE RETAIN ALL PACKING UNTIL YOU HAVE COMPLETED ASSEMBLY.

Information about your Pine furniture.

Our pine furniture ranges have been carefully crafted from solid wood and natural wood veneers. Each piece of pine has unique characteristics such as knots, variances in shading and graining. These are part of the natural character of the furniture itself.

Caring for your Pine furniture.

Extreme temperature can cause slight movements in the wood itself so please avoid placing your furniture close to radiators or other direct sources of heat. Humidity should also be avoided.

Please avoid exposing your furniture to continued bright sunlight as it can affect the colour.

Any fluid spills should be removed as quickly as possible.

Always lift your furniture when moving as dragging may cause damage to your furniture or flooring.

After care.

Wipe the surfaces with a dry cloth and occasionally apply household furniture polish. For the models with drawers, we also recommend you use household spray polish occasionally on drawer grooves and runners as this will aid use. Please do not use detergents or chemicals on your furniture.

PARTS LIST

PAA x04 30mm Ø8	PAE x26 35mm Ø4,0 P3
PT x08 7 x 70mm	PS x01
PAI x01 Warning! Keep out of reach from children, Keep away from eyes, if product gets into eye rinse thoroughly and repeatedly with water. Do not digest, if swallowed seek medical advice from doctor.	

RETAIN ALLEN KEY TO TIGHTEN BOLTS WHEN NECESSARY.

BEFORE YOU START ASSEMBLY

Please check that you have all the correct parts and fittings as detailed in the Parts List above.

For assistance, please email us at: cs@furnishedash.com

BATCH NUMBER **2021-0337**

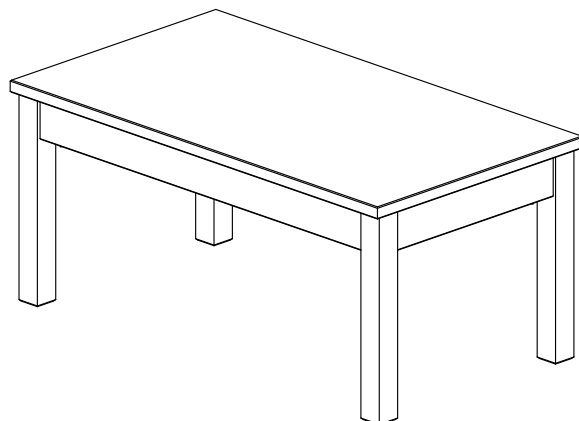

PLEASE RETAIN THIS INSTRUCTION LEAFLET FOR FUTURE REFERENCE.

01

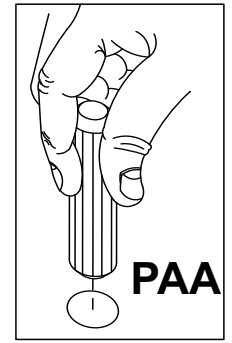
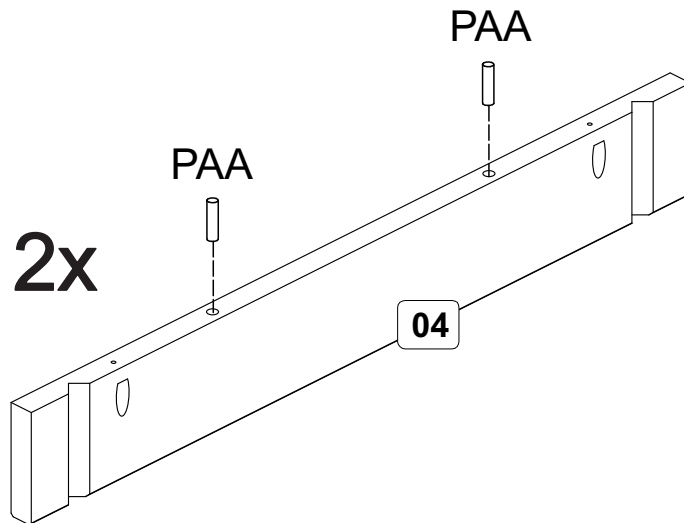

"Use a small drop of glue"

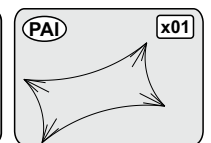
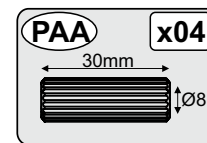
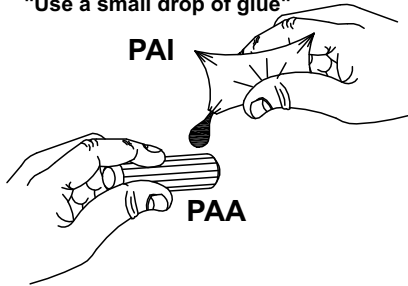

02

Build your furniture on a soft clean cover to stop the components getting marked during assembly

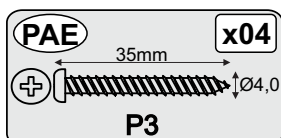
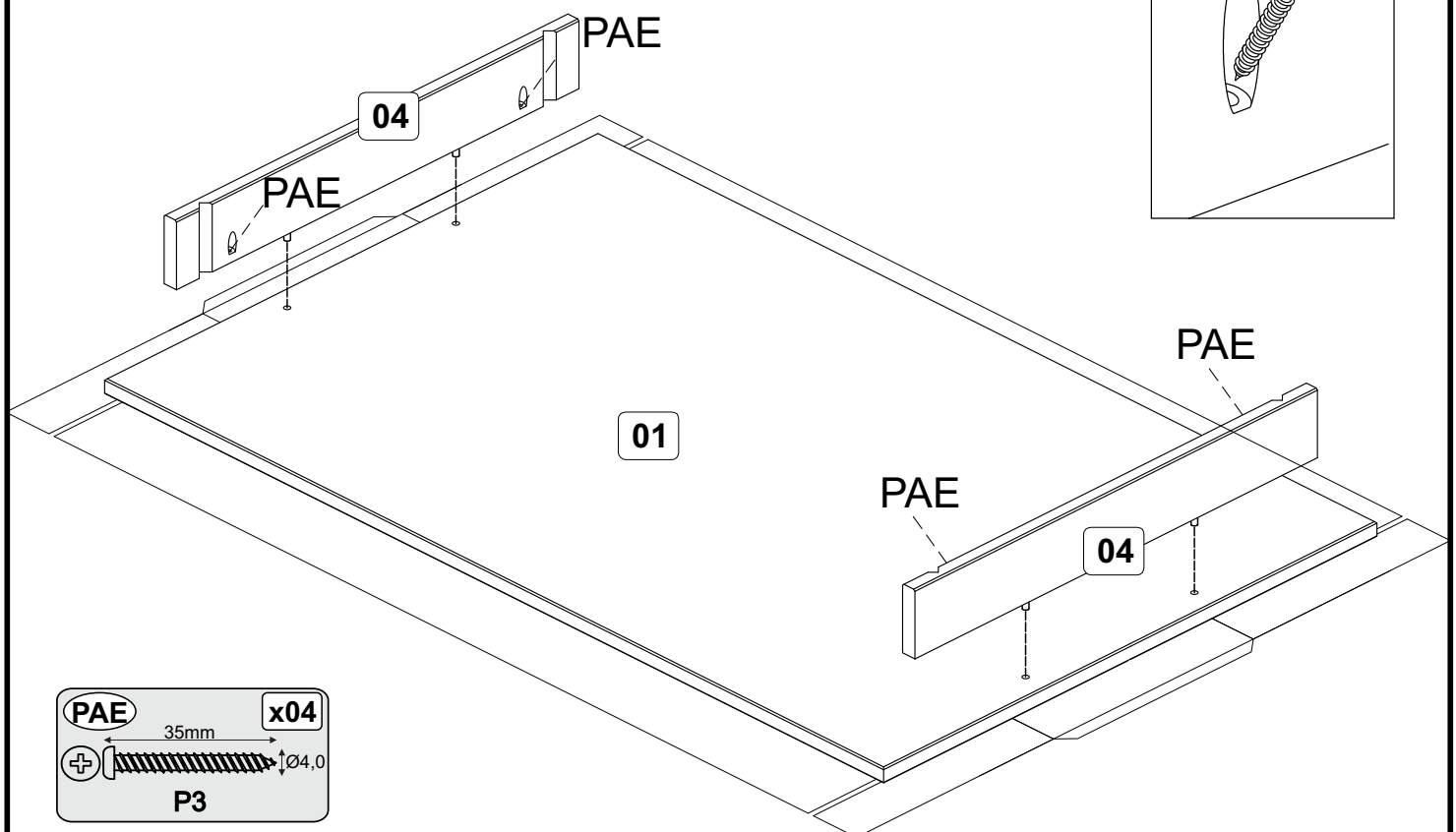
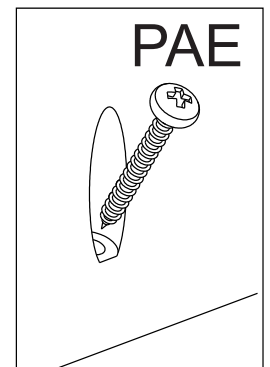

03

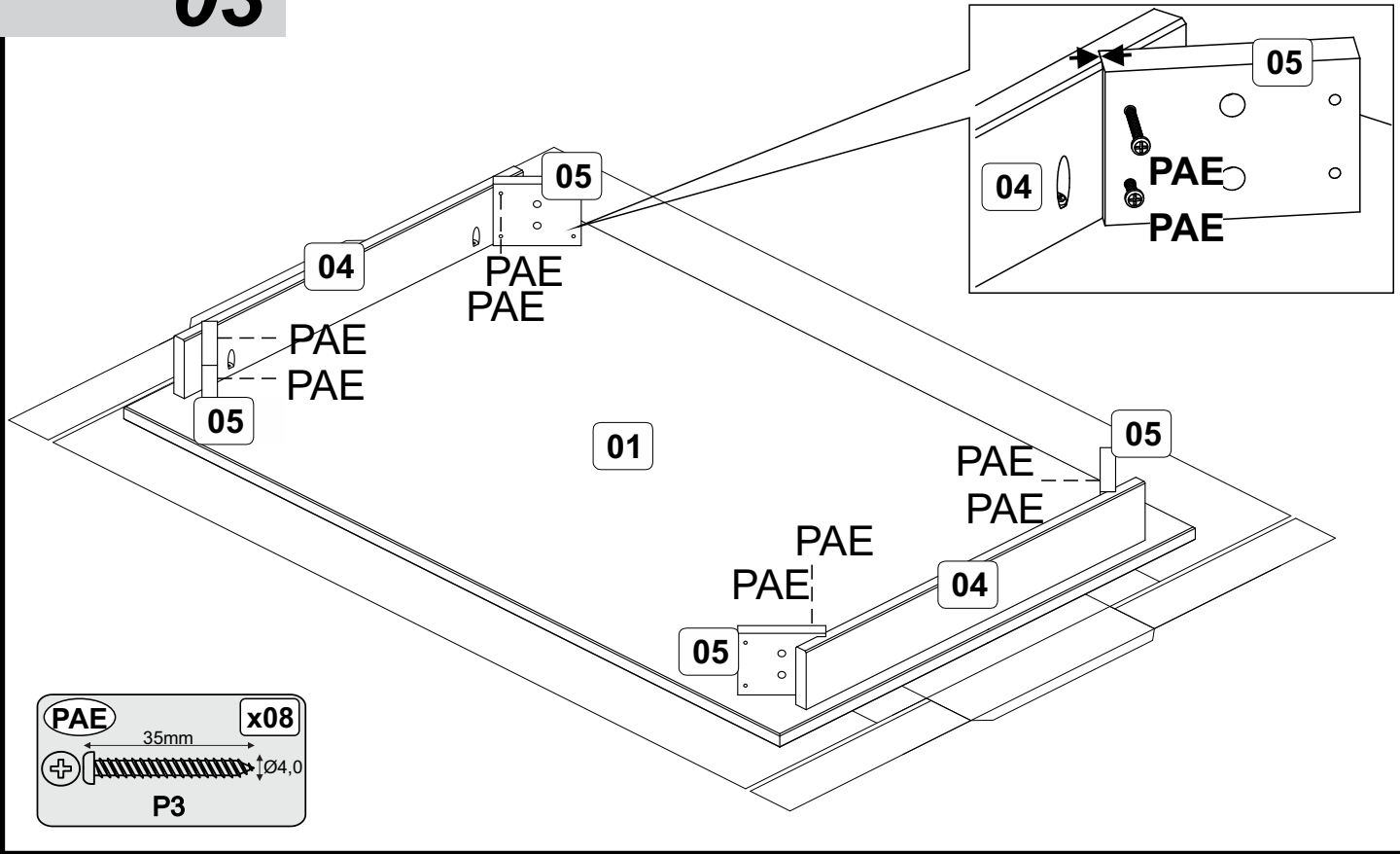

04

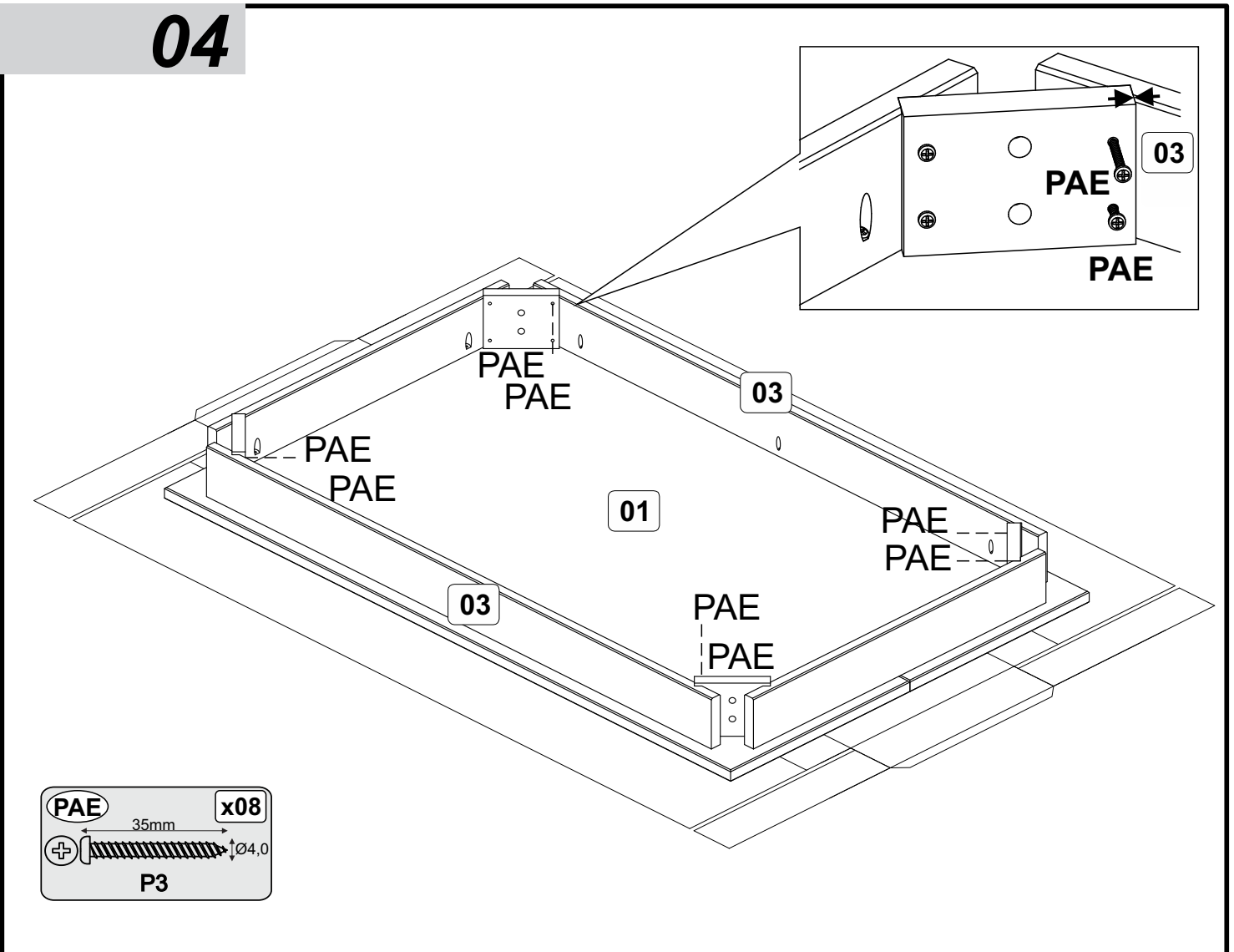

05

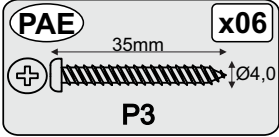
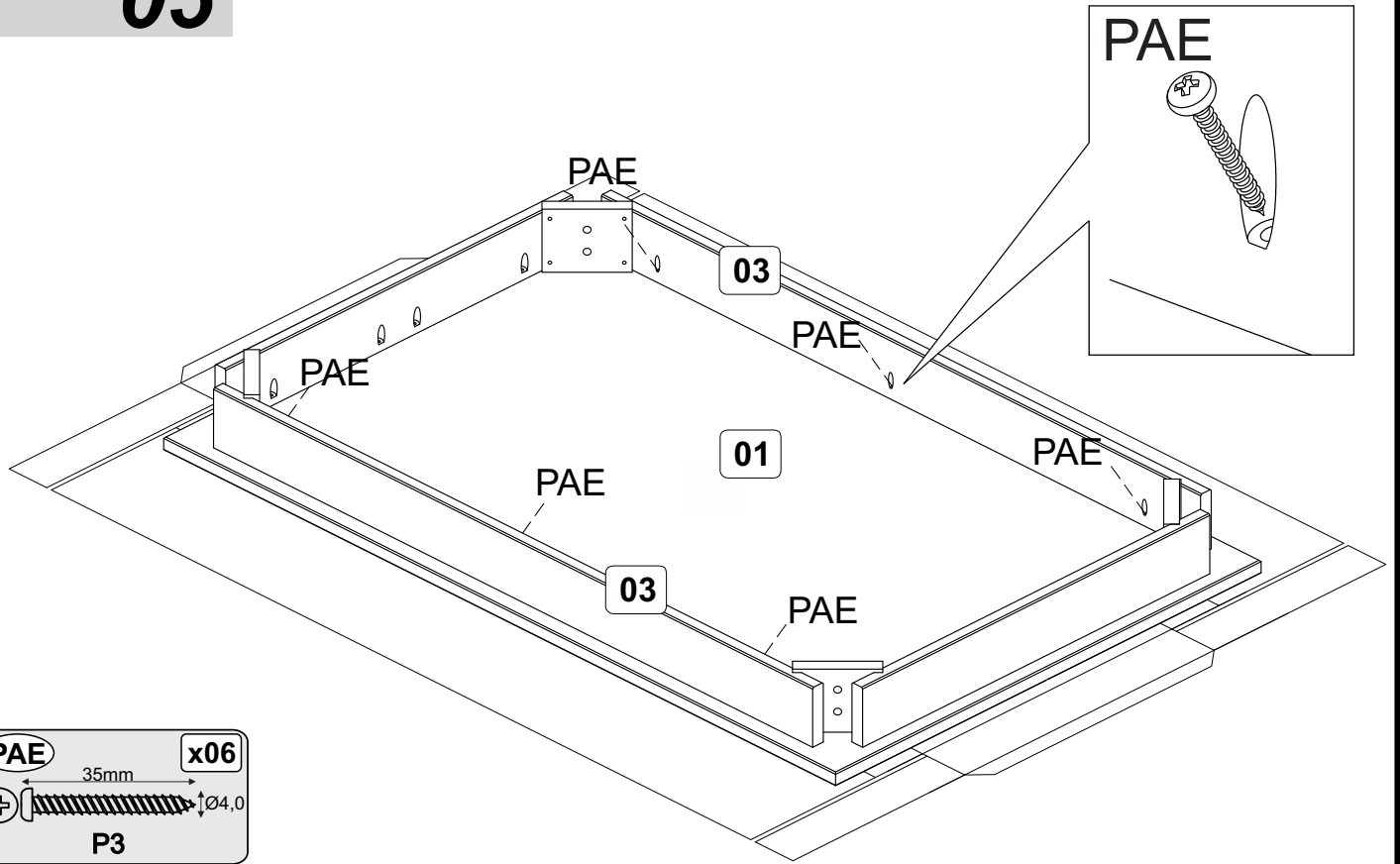

06

